





GC-7

Features

-  SENSOR
-  ENCODER
-  COUNTER
-  INFORMATION

Programmable Touch Panel (GC Type)

Inherited the GC-5□ display.

- 10.4-inch TFT color Model number: GC-76LC
- 5.7-inch STN color Model number: GC-73LCL-R
- 5.7-inch STN monochrome Model number: GC-73LM-R



HMI Lineup

Programmable
Touch Panel

HMI Software

Features

- Shifted from the GC50 series.

The applications of the GC-50 series (GC-53LC3, GC-53LM3, and sGC-56LC2) are partially inherited.

The applications can be replaced within restrictions.

- ScreenCreator5 is usable.

The ScreenCreator5 drawing software has been upgraded. You can draw in the same way as with the GC-50 series.

Restrictions from the GC50 Series

1. Drawing software

Prepare ScreenCreator5 Ver3.0 or later.

You can download the drawing software from Koyo Electronics' website free of charge.

2. Panel cutout dimensions

The panel cutout dimensions are not changed.

The display can be installed in the existing holes for attaching the control panel as is.

3. Dimensions

The 5.7-inch type is 7.1 mm thicker in depth.

The 0.4-inch type is 3.0 mm wider in width.

Since the location and size of mounting brackets and external connection connectors are different, make sure that there are no interfering parts inside and outside the board.

4. Power Supply

The 5.7-inch type is connected to the main body, not by terminal block but by connector (bundled item). The 10.4-inch type has been changed to 24 V DC specification.

If you use the GC7 at 100 V/200 V AC, use the optional EA-AC or prepare a commercial AC/DC power supply. (If the EA-AC is used, the depth of the product becomes the main body + 36.1 mm.)

5. Confirmation of PLC models

PLCs that can be used are largely limited. Also, the shapes of connection connectors are different. (M:N communications also cannot be used.)

6. Confirmation of peripheral devices

The GC70 series has only one serial port.

Also note that there are no parallel ports or RAS output / reset input.

7. Touch panel operation

Since an analog-type touch panel is used, there are the following restrictions.

- You cannot press two, three, or four points at the same time.
- The resolution of the touch panel is different.

Since the GC50 series has a different resolution (16 x 12 or 32 x 24) from the GC70 series (1,024 x 1,024), the operational feeling may be different.

8. When K-BASIC is used

There are restrictions on usable instruction words.

9. When option products are used

The digital I/O cannot be used.

The backup data in a CF card is not compatible. If the data is backed up by a CF card for the GC50 series, restore the screen data to ScreenCreator5 once. Each setting data needs to be reset for the GC70 series.

10. How to download screen data

Screen data can be transferred via USB.

11. Other

There may be restrictions in addition to the items mentioned above.

Viewing angle of the screen, appearance of reduced / enlarged characters, appearance of the black-and-white type (difference between blue type LCD and black-and-white mode), etc.

* When you change models, it is recommended that you check the operations using actual equipment once.





GC-A

GC-7

EA7

GC-7

Specifications

PLC HMI SENSOR ENCODER COUNTER INFORMATION 

HMI Lineup

Programmable
Touch Panel

HMI Software

GC-A

GC-7

EA7

How to Transfer Software

- 1 Read the screen data project using ScreenCreator5 (Ver3.0 or later).
- 2 Change the target panel to the new model (GC-73LM-R / GC-73LCL-R / GC-76LC) using ScreenCreator5 (Ver3.0 or later).
- 3 Recompile the screen data using ScreenCreator5 (Ver3.0 or later).
- 4 Download the compilation data to the new model using ScreenCreator5 (Ver3.0 or later).

* In a new model, it is not necessary to change to the download mode at hardware side like previous models.

If the computer and the display are connected via a USB cable and the data is downloaded from a computer, the display automatically changes to the download mode and automatically restarts after the completion of the download.

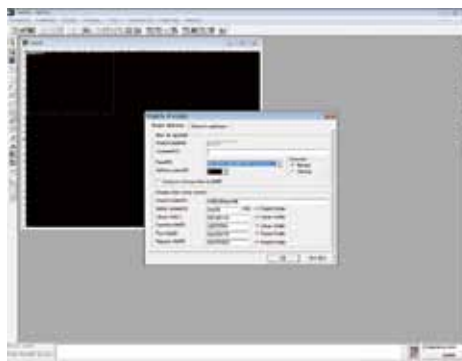

Each Part Names and Descriptions

Standard

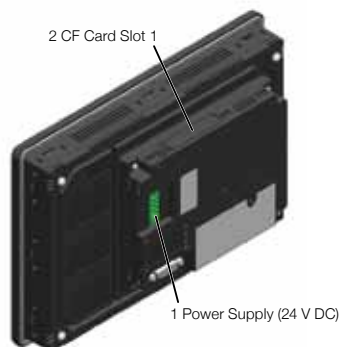

Expansion (Option is installed)

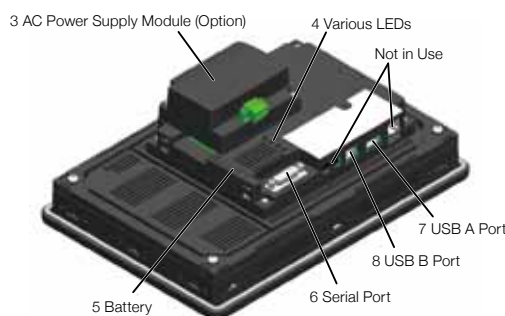

- 1 Power supply (24 V DC)
- 2 CF card slot
- 3 AC power supply module (Option)
- 4 Various LEDs
- 5 Battery
- 6 Serial port
- 7 USB A port
- 8 USB B port

Can be used for the power supply in the same conditions as GC-53L□3.

The screen data can be uploaded/downloaded from a CF card.

Can be used with a power supply under the same conditions as the GC-56LC2.

You can check the power supply / status / transmission and reception.

Retain clock data / SRAM.

For connection to a PLC

The screen data can be uploaded/downloaded from a USB memory.

The screen data can be uploaded/downloaded from drawing software.

Options

Name	Model Number	
AC Power Supply Module	EA-AC	
Compact Flash	EA-CF-CARD	
D-sub Terminal Block Conversion Adaptor (For RS-422/485)	EA-COMCON-3	
D-sub Angle Conversion Adaptor	EA-ADPTR-4	
Protection Sheet	For 5.7-inch type	EA-6-COV2
	For 10.4-inch type	EA-10-COV2
Surface Cover	For 5.7-inch type	GC-S3SH-32
	For 10.4-inch type	EA-10-COV3-SG

Connection Cables

EA-2CBL	SJ, DL05/06/205, SZ, PZCPU Modular 6-pin
EA-2CBL-1	DL06/250-1/260,SZ-4M,PZ3 High-density D-sub 15-pin
EA-4CBL-1	D4-CPU programmer port D-sub 15-pin
EA-4CBL-2	D4-CPU general-purpose port D-sub 25-pin
EA-MITSU-CBL-2	Mitsubishi computer link D-sub 9P
EA-OMRON-CBL-1	D-sub 9-pin for Omron

Cable length: 3 m

Expendable Supplies

Name	Model Number	
Gasket	For 5.7-inch Type	—
	For 10.4-inch Type	EA-10-GSK-SG
Mounting Brackets	For 5.7-inch Type	EA-MG-BZ
	For 10.4-inch Type	EA-BRK-2G
Battery	D2-BAT-1	
Plug for Main Body Power Supply	EA-DC-CON	
Plug for AC Power Supply	EA-AC-CON	

GC-7

Specifications

Main Body Specifications

Model Number		GC-73LM-R	GC-73LCL-R	GC-76LC
Display	Device Size	5.7-inch		10.4-inch
	Display Device	STN monochrome LCD		TFT color LCD
	Display Color	Black-and-white mode (15 gradations)		65,536 color
	Number of Dots	320 x 240 (QVGA)		640 x 480 (VGA)
	Brightness Control*1	Set from the system screen of the main body display. (Setting components can be arranged from the drawing software.)		
	Backlight	Cold-cathode tube Average life: Continuous lighting for 50,000 hours or longer / 25°C	LED	
	Replacement of Backlight	Impossible		Possible
	Touch Panel	Analog resistive type, Resolution: 1,024 W x 1,024 H		
External Interface	For PLC Connection	Serial	Start-stop synchronization, RS-232C, RS-422/485 (2/4-wire system), D-sub 15-pin (Female) x 1 Data length: 7/8 bit, parity: None/Odd/Even, stop bit: 1/2 bit Transmission speed (bps): 1,200/2,400/4,800/9,600/19,200/38,400/57,600/115,200	
	Screen Data Transfer		USB (B) 1.1 x 1	
	CF Card Slot 1	No	Compact Flash (Limited to 3.3 V) TYPE I/II x 1*2	
	USB	USB (A) 1.1 x 1		
General Specifications	Supply Voltage	24 V DC		
	Allowable Power Range	20.4 to 28.8 V DC, allowable ripple, within 100 mVp-p, allowable instantaneous power failure time, within 5 ms		
	Power Consumption	Approx.9 W (24 V DC, at main body standalone operation)	Approx.10 W (24 V DC, at main body standalone operation)	Approx.17 W (24 V DC, at main body standalone operation)
	Use Ambient Temperature	0 to 50°C		
	Storage Ambient Temperature	-20 to 60°C		
	Use / Storage Ambient Humidity	10 to 85% RH (No condensation)		
	Noise Resistance	1000 V AC p-p, pulse width 1 μs, rise time 1 ns, between DC power supply input terminal and FG terminal (Cased on noise simulator)		
	Withstand Voltage	1000 V AC, 1 min, between DC power supply input terminal and FG terminal		
	Insulation Resistance	10 MΩ or higher (500 V DC), between DC power supply input terminal and FG terminal		
	Vibration Resistance	Compliant with JIS C 0911, vibration acceleration: constant acceleration 19.6 m/s ² , frequency range: 5 to 55 Hz to 5 Hz, vibration time: vertical direction (Y direction) 4H, horizontal and front-back direction (X and Z direction) 2H, sweep cycle: 5 → 55 → 5, 1 octave / min (10%)		
	Impact Resistance	Compliant with JIS C 0912, maximum acceleration 98 m/s ² (10 G), duration of action: 11 ms, number of impacts: 10 times each in perpendicular direction		
	Electrostatic Discharge Resistance	Atmospheric discharge: 8 kV, application places: bezel, touch panel, contact discharge: 4 kV, application places: left/right and front/back of the panel		
	Surrounding Atmosphere in Place of Use	No corrosive gases		
	Grounding	D-class grounding		
	Protective Structure	IP65 (Only front, when gasket is used.)		
	Dimensions (mm)	197 W x 152 H x 54.1 D		299.0 W x 209.0 H x 70.0 D
	Weight (g)	660	630	1480
	Panel Cutout Dimensions (mm)	179.0 W x 140.0 H		85 W x 191 H
	Cooling System	Natural air-cooling		
	Compliant Standards	UL508 (Scheduled to acquire), EMC directive (CE marking: Self-declared), CE EN61131-2, EMI CISPR11 Class A, unnecessary radiation measurement, field intensity measurement, magnetic field strength measurement (EN55011) EMS susceptibility immunity measurement Class A EN61000-4-2 Electrostatic discharge immunity test, EN61000-4-3 Radiation magnetic field immunity test, EN61000-4-4 First transient burst immunity test, EN61000-4-5 Surge immunity test, EN61000-4-6 Conductivity immunity test		
Accessories	QSG (Quick Start Guide) manual Mounting brackets (4 units) Power plug		QSG (Quick Start Guide) manual Mounting brackets (6 units) Power plug (Bundled with mounting brackets)	

*1 Since this display uses a cold-cathode tube for the backlight, the brightness widely fluctuates according to the conditions shown below. Consider the described brightness as a target.



Ambient temperature, installation angle of the product, elapsed time since power-on, duration of use of the product, and number of product power supply ON/OFF cycles

*2 Only the specific card can be used.

* Regarding the EA-AC specifications, see P.345.

GC-7

Specifications

PLC HMI SENSOR ENCODER COUNTER INFORMATION 

HMI Lineup

Programmable
Touch Panel

HMI Software

GC-A

GC-7

EA7

List of Connected Devices

Manufacturer	Series	ScreenCreator5	ScreenCreator5 Properties of Project
Koyo	KOSTAC-S	Koyo (KOSTAC S)	
		Koyo (CCM3)	
	DL Series	Koyo (DL Series)	
		Koyo (DL Series MODBUS)	
Mitsubishi	MELSEC-AnN	Mitsubishi (AnN/AnS) (LINK)	
	MELSEC-AnS	Mitsubishi (AnN/AnS) (LINK) (High speed communication)	
	MELSEC-AnA	Mitsubishi (AnA/AnU) (LINK)	
	MELSEC-AnU	Mitsubishi (AnA/AnU) (LINK) (High speed communication)	
	MELSEC-QnA	Mitsubishi (QnA) (LINK)	
		Mitsubishi (QnA) (LINK) (High speed communication)	
MELSEC-Q	Mitsubishi (QnA) (LINK)		
		Mitsubishi (QnA) (LINK) (High speed communication)	
Omron	SYSMAC C	Omron (C)	
	SYSMAC CQM1	Omron (C)	
	SYSMAC CS1	Omron (CS1)	
Sharp	New Satellite JW	Sharp (CPU direct connection)	
		Sharp (LINK)	
JTEKT	TOYOPUC	JTEKT (PC2)	
		JTEKT (PC3)	
Yaskawa	Inverter	Yaskawa (Inverter)	
Yokogawa	FACTORY ACE	Yokogawa (CPU_No.*)	
		Yokogawa (CPU_No.*) (High speed communication)	
	FA-M3	Yokogawa (CPU No. variable)	
		Yokogawa (CPU No. variable) (High speed communication)	
	Temperature Controller	Yokogawa (CPU No. variable)	
		Yokogawa (CPU No. variable) (High speed communication)	
Keyence	KZ Series	Omron (C)	
		Mitsubishi (AnA,AnU) (LINK)	
		Mitsubishi (AnA,AnU) (LINK) (High speed communication)	
		Mitsubishi (AnN/AnS) (LINK)	
		Mitsubishi (AnN/AnS) (LINK) (High speed communication)	
Toyo Denki	Digital Controller	Toyo Denki (μ -GPCH)	

Supported PLCs as of May 2012

Largely restricted compared with the GC50 series.

If devices other than those above are connected, it is impossible to shift to the GC70 series.

GC7

Dimensions

Dimensions

GC-73L□-R

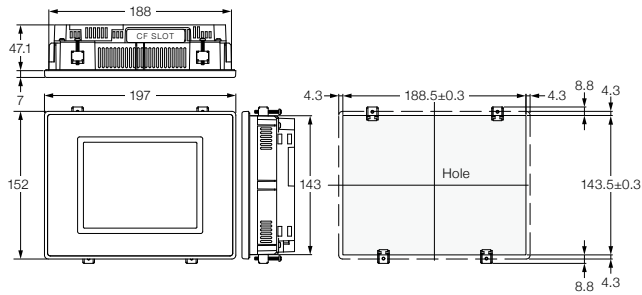



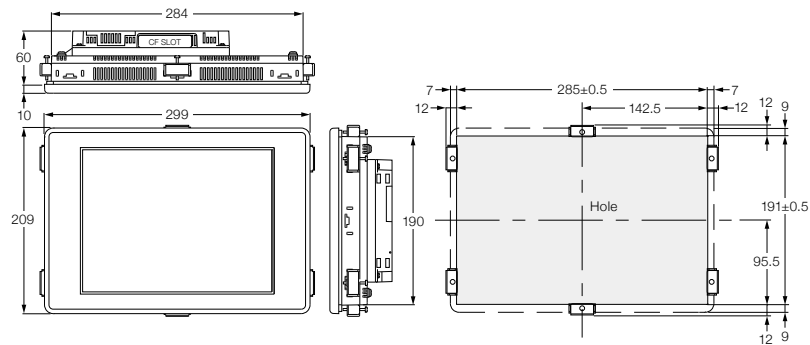

GC-76LC

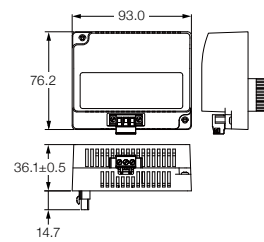

EA-AC



-  SENSOR
-  ENCODER
-  COUNTER
-  INFORMATION

- HMI Lineup
- Programmable Touch Panel
- HMI Software

- GC-A
- GC-7**
- EA7

Compatibility with the GC50 Series

Items	5.7-inch Monochrome		5.7-inch Color				
	Compatibility	GC-53LM3	GC-73LM-R	Compatibility	GC-53LC3	GC-73LCL-R	
Appearance	△	Light gray	Gray	△	Light gray	Gray	
Dimensions (mm)	△	197.0 W x 152.0 H x 47.0 D	197.0 W x 152.0 H x 54.1 D *Slightly thick	△	197.0 W x 152.0 H x 47.0 D	197.0 W x 152.0 H x 54.1 D *Slightly thick	
Panel Cutout Dimensions (mm)	○	188.5±0.3 W x 143.5±0.3 H		○	188.5±0.3 W x 143.5±0.3 H		
Mounting Brackets	×	Both the position and shape are different.		×	Both the position and shape are different.		
Power Supply	○	24 V DC		○	24 V DC		
	Connector	×	Terminal block	Connector	×	Terminal block	Connector
LCD Panel	△	5.7" (Blue, single gradation)	5.7" (Black-and-white mode, 15 gradations)	○	5.7" color	5.7" color	
	View Angle	△	30° (up/down) 30° (left/right) Room temperature (25°C)	20° (up)40° (down) 45° (left/right) Room temperature (25°C)	△	25° (up)70° (down) 35° (left/right) Room temperature (25°C)	20° (up)35° (down) 50° (left/right) Room temperature (25°C)
	Brightness	△	300 cd/m ²	150 cd/m ²	△	250 cd/m ²	200 cd/m ²
	Life	○	50,000 hours		○	30,000 hours	50,000 hours
Touch Panel	×	Matrix (16 x 12 pieces)	Analog type	×	Matrix (16 x 12 pieces)	Analog type	
Serial Port 1	△	D-sub 9-pin (Female)	D-sub 15-pin (Female)	△	D-sub 9-pin (Female)	D-sub 15-pin (Female)	
Serial Port 2	×	Terminal block (RS-422/485)	None	×	Connector (RS-422/485)	None	
Screen Data Transfer	△	Serial Port 1	USB (B)	△	Serial Port 1	USB (B)	
CF Card	△	The option is required.	None Can be substituted with a USB memory There is no data compatibility with conventional models.	△	The option is required.	None Can be substituted with a USB memory There is no data compatibility with conventional models.	
Digital Input/Output	×	The option is required.	None	×	The option is required.	None	
Drawing Software	△	ScreenCreator5	ScreenCreator5 Ver3.0 or later	△	ScreenCreator5	ScreenCreator5 Ver3.0 or later	
Items	10.4-inch Color						
	Compatibility	GC-56LC2	GC-76LC				
Appearance		Gray	Gray				
Dimensions (mm)	△	296.0 W x 209.0 H x 77.5 D	299.0 W x 209.0 H x 70.0 D				
Panel Cutout Dimensions (mm)	○	285.0±0.5 W x 191.0±0.5 H					
Mounting Brackets	×	Both the position and shape are different.					
Power Supply	△	100 V/200 V AC	24 V DC *When used with 100 V/ 200 V AC, the optional EA-AC is required.				
	Connector	×	Terminal block	Connector			
LCD Panel	○	10.4" color					
	View Angle	○	30° (up)20° (down) 45° (left/right) Room temperature (25°C)	65° (up)45° (down) 65° (left/right) Room temperature (25°C)			
	Brightness	○	200 cd/m ²	270 cd/m ²			
	Life	○	25000 hours	50000 hours			
Touch Panel	×	Matrix (32 x 24 pieces)	Analog type				
Serial Port 1	△	D-sub 9-pin (Female)	D-sub 15-pin (Female)				
Serial Port 2	×	Terminal block (RS-422/485)	None				
Serial Port 3	×	The option is required.	None				
Screen Data Transfer	△	Serial Port 1	USB (B)				
CF Card	△	The option is required.	Available Can be substituted with a USB memory There is no data compatibility with conventional models.				
Digital Input/Output	×	The option is required.	None				
Parallel Ports	×	Available	None				
RAS Output	×	Available	None				
Reset Input							
Drawing Software	△	ScreenCreator5	ScreenCreator5 Ver3.0 or later				