

APS-GMC Series

Features

Metal Cylinder, 2-wire DC System

- Like a limit switch
- Wire-saving because of 2-wire type
- Low power consumption 0.55 mA or less
- Offers reliable installation through stable detection range indicator
- Supports sinking / sourcing connection



Type

2-wire DC System

Output Form	Operating Distance (mm)			Output Form	Model Number	Remarks
M8 Flush Mount Type	2			NO	APS2-8GMC2-Z	
M12 Flush Mount Type	3			NO	APS3-12GMC2-Z	
M18 Flush Mount Type	7			NO	APS7-18GMC2-Z	

Operation

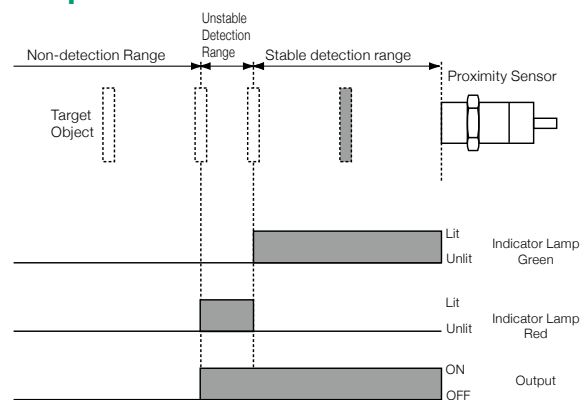

Note) Regarding the standard target object, the indication light color is changed at a position of about 80% of the operating distance. When the shape and material of the target object are different from the standard target object, the indication light color may be made shorter than the 80% position of the operating distance.





- HMI
- SENSOR
- ENCODER
- COUNTER
- INFORMATION

- Proximity Sensor Lineup
- Selection Guide
- Outline
- Cylinder Type
- Square Type
- Capacitive Type

- APS-GMC
- APS-GMD
- APS-GK
- APS-30/31
- APS-CK

APS-GMC Series

2-wire DC System Flush Mount Type

PLC HMI SENSOR ENCODER COUNTER INFORMATION Proximity
Sensor Lineup

Selection Guide

Outline

Cylinder Type

Square Type

Capacitive Type

APS-GMC

APS-GMD

APS-GK

APS-30/31

APS-CK

Effective Operating Distance		2 mm ±10%	3 mm ±10%	7 mm ±10%
Photo				
Remarks		Equipped with stable detection range indicator Equipped with short-circuit protection		
Output Form	NO	Model Number APS2-8GMC2-Z	APS3-12GMC2-Z	APS7-18GMC2-Z
		Price Open	Open	Open
Rated Working Voltage		12/24 V DC (10 to 30 V DC)		
Standard Target Object (mm)		Iron 8 x 8 x 1 t	Iron 12 x 12 x 1 t	Iron 18 x 18 x 1 t
Guaranteed Operating Distance		0 to 1.4 mm	0 to 2.1 mm	0 to 4.9 mm
Reaction Material		Iron/Non ferrous metal (Operating distance changes depending on materials.)		
Hysteresis		15% or less of operating distance		
Operating Cycle Frequency		2 kHz	1.5 kHz	500 Hz
Rated Working Current		3 to 100 mA		
Voltage Drop		3 V or lower		
Off-state Current		0.55 mA or lower		
Indicator Lamp		Operation indication: Red or green lights up when output is ON. Installation indication: Green lights up within the stable detection range.		
Use Ambient Temperature		-25 to +70°C		
Temperature Characteristics		Within ±10% (At the operating distance at +25°C)		
Withstand Voltage		1,000 V AC 50/60 Hz (1 minute)		
Insulation Resistance		50 MΩ or higher (500 V DC)		
Vibration Resistance		Double amplitude: 1.5 mm, 10 to 55 Hz (2 h each for X, Y and Z direction)		
Impact Resistance		980 m/s ² , within 11 ms (10 times each for X, Y and Z direction)		
Protection Level		IP67		
Case Material	Case	Stainless steel	Brass nickel plate	
	Detector Surface	PBT	PBT	
	Indicator Lamp	Nylon	Nylon	
	Cord Protection	PBT	PBT	
Lead Wire		Oilproof cable 2 m Outside diameter (Approx. ϕ 4.1) 0.3 mm ² , 2 core		Oil-resistant cable 2 m Outside diameter (Approx. ϕ 5.7) 0.5 mm ² , 2 core
Tightening Torque		Range up to 10 mm from the detector surface: 9 Nm or less Range that is more than 10 mm from the detector surface on the cable side: 12 Nm or less	Range up to 10 mm from the detector surface: 20 Nm or less Range that is more than 10 mm from the detector surface on the cable side: 30 Nm or less	70 Nm or less
Weight (g)		Approx. 50	Approx. 60	Approx. 130

APS-GMC Series

Connection and Operation

Connection / Operation

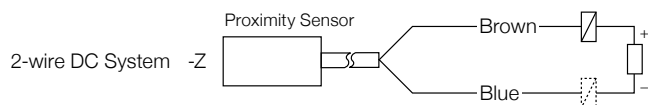

The load can be connected to either side of the power source.
Note: indicates a load.

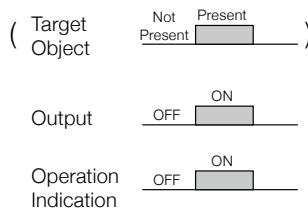

Installation / Effects of Surrounding Metal

Since the proximity sensor is affected by surrounding metal, install it remotely enough from the described dimensions.

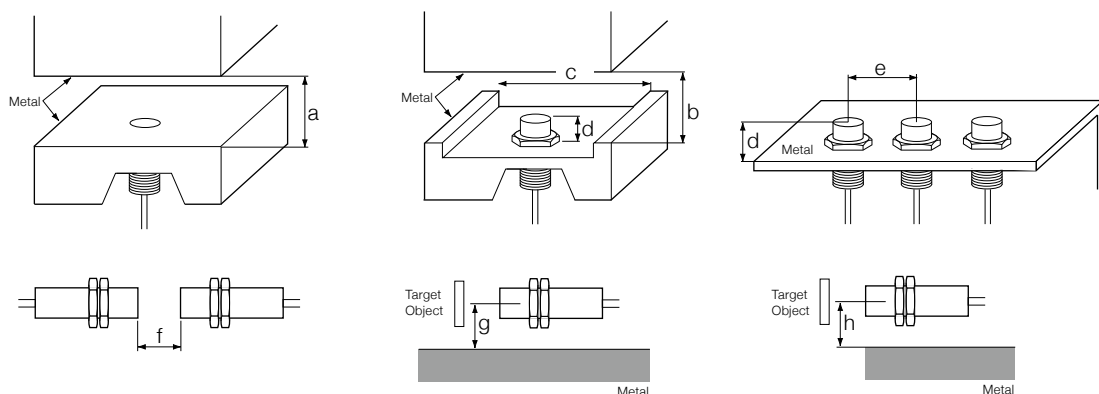

(Unit: mm)

Model Number	a	b	c	d	e	f	g	h
APS2-8GMC2-Z	8	—	—	—	16	20	8	4
APS3-12GMC2-Z	8	—	—	—	24	30	9	6
APS7-18GMC2-Z	20	—	—	—	36	50	13.5	9

Detection Range Diagram (Representative Examples)

APS2-8GMC2-Z

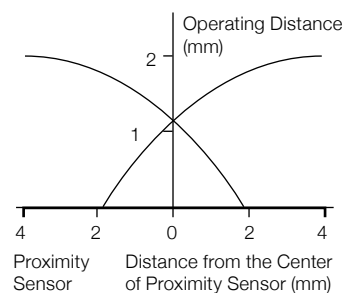

APS3-12GMC2-Z

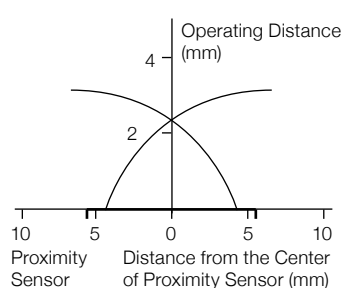

APS7-18GMC2-Z

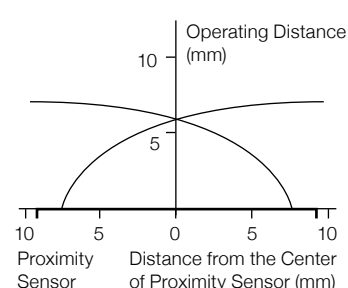

Shape Based Characteristics (Representative Examples)

APS2-8GMC2-Z

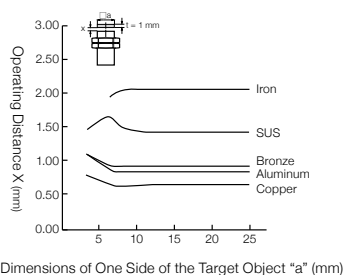

APS3-12GMC2-Z

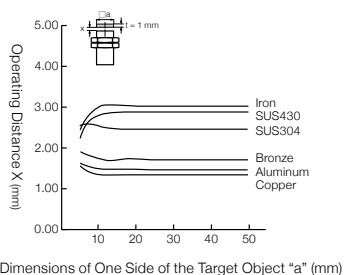



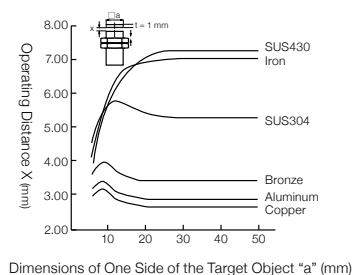

APS7-18GMC2-Z



APS-GMC Series

Dimensions

PLC HMI SENSOR ENCODER COUNTER INFORMATION Proximity
Sensor Lineup

Selection Guide

Outline

Cylinder Type

Square Type

Capacitive Type

APS-GMC

APS-GMD

APS-GK

APS-30/31

APS-CK

Dimensions (Unit: mm)

APS2-8GMC2-Z

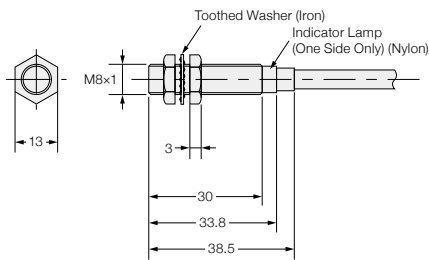

APS3-12GMC2-Z

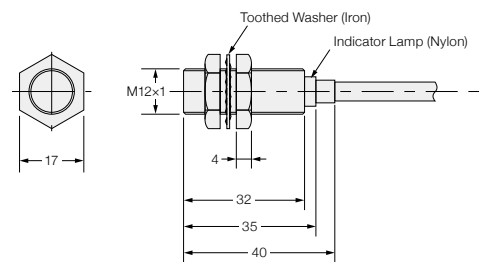

APS7-18GMC2-Z

