

# CS Series

## Features

### Capacitance Type

- Metal cylinder/Resin cylinder/Square type
- Non-metal objects such as wood, paper, plastic and water can be detected.
- The operating distance is adjustable with a potentiometer.
- DC voltage / NPN output



### Type

#### DC Voltage Output Type/3-wire DC System

Output Form		Operating Distance (mm)			Output Form	Model Number	Remarks
Resin Cylinder M22	Non-flush Mount Type	5			NPN NO	CS-31-5N*	
		15			DC voltage	CS-85-15T	
Metal Cylinder M30	Non-flush Mount Type	5			NPN NO	CS-85-15N	
		10			DC voltage	CS-16-5T	
Square type	Non-flush Mount Type	5			NPN NO	CS-16-5N	
		10			NPN NO	CS10-34CU-E	

\* For installation, use the provided dedicated resin nut.

HMI

SENSOR

ENCODER

COUNTER

INFORMATION

Proximity  
Sensor Lineup

Selection Guide

Outline

Cylinder Type





Square Type

Capacitive Type

CS

## CS Series

## DC Voltage Output Type/3-wire DC System Non-flush Mount Type

PLC HMI SENSOR ENCODER COUNTER INFORMATION Proximity  
Sensor Lineup

Selection Guide

Outline

Cylinder Type

Square Type

Capacitive Type

CS

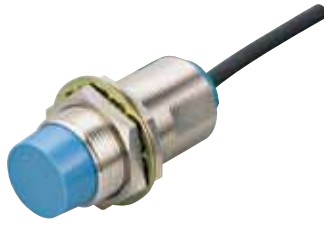
Effective Operating Distance	5 mm ±10%		15 mm ±10%	
Photo				
Remarks	Resin Cylinder Type		Metal Cylinder Type	
Output Form	DC Voltage	Model Number	CS-85-15T	
		Price	Open	
	NPN NO	Model Number	CS-31-5N*	
		Price	Open	
Rated Working Voltage	DC Voltage Output Type	12 V DC (10 to 16 V DC) Allowable ripple rate: 10% p-p or less		
	DC Switching type (N Type)	24 V DC (20 to 30 V DC) Full wave rectification power supply can be used. (20 to 30 V DC mean value)	12/24 V DC (10 to 30 V DC) Full wave rectification power supply can be used. (10 to 30 V DC mean value)	
No-load Current	T type: 27 mA or lower N type: 20 mA or lower			
Standard Target Object (mm)	Iron 50 x 50 x 1 t (Grounding state)			
Reaction Material	Iron/Non ferrous metal/Non-metal (Operating distance changes depending on materials.)			
Effective Operating Distance	The operating distance can be changed from a multi-rotation volume.			
Hysteresis	Approx. 20%			
Operating Cycle Frequency	50 Hz			
Output	T Type	Output impedance: 1.8 kΩ (Output standard: 8P6N)		
	N Type Rated Working Current	100 mA (Load voltage: Not more than 50 V)		
Voltage Drop (N Type)	2.0 V or lower			
Off-state Current (N Type)	200 μA or less			
Indicator Lamp	Operation indication			
Use Ambient Temperature	-25 to +70°C			
Temperature Characteristics	Within ±20% (At the operating distance at +20°C)			
Withstand Voltage	500 V AC 50/60 Hz (1 minute)			
Insulation Resistance	5 MΩ or higher (500 V DC)			
Vibration Resistance	Double amplitude: 1.5 mm, 10 to 55 Hz (2 h each for X, Y and Z direction)			
Impact Resistance	600 m/s <sup>2</sup> , within 11 ms (10 times each for X, Y and Z direction)			
Protection Level	IP65			
Case Material	Polycarbonate		Brass nickel plate (Detector surface: Polycarbonate)	
Lead Wire	Oilproof vinyl chloride cable 1.5 m Outside diameter (Approx. $\phi$ 4.5) 0.3 mm <sup>2</sup> , 3 core		Oilproof vinyl chloride cable 2 m Outside diameter (Approx. $\phi$ 6) 0.5 mm <sup>2</sup> , 3 core	
Tightening Torque	3 Nm or less		20 Nm or less	
Weight (g)	Approx. 80		Approx. 250	

\* When installing the CS-31-5T and CS-31-5N, use the provided dedicated resin nuts.

## CS Series

DC Voltage Output Type/3-wire DC System Non-flush Mount Type



HMI



SENSOR



ENCODER



COUNTER



INFORMATION

Proximity  
Sensor Lineup

Selection Guide



Outline

Cylinder Type

Square Type

Capacitive Type

CS

Effective Operating Distance		10 mm ±10%	5 mm ±10%
Photo			
Remarks		Square type	Square type
Output Form	DC Voltage	Model Number	CS-16-5T
		Price	Open
	NPN NO	Model Number	CS10-34CU-E
Price		Open	Open
Rated Working Voltage		12/24 V DC (10 to 30 V DC) Allowable ripple rate: 3% p-p or less	T type: 12 V DC (10 to 16 V DC) Allowable ripple rate: 10% p-p or less  N type: 12/24 V DC (10 to 30 V DC) Full wave rectification power supply can be used. (10 to 30 V DC mean value)
No-load Current		20 mA or lower	T type: 27 mA or lower N type: 20 mA or lower
Standard Target Object (mm)		Iron 50 x 50 x 1 t (Grounding state)	
Reaction Material		Iron/Non ferrous metal/Non-metal (Operating distance changes depending on materials.)	
Effective Operating Distance		10 mm ±10%	The operating distance can be changed from a multi-rotation volume.
Hysteresis		Approx. 20% or less	Approx. 20%
Operating Cycle Frequency		Up to 10 Hz	50 Hz
Output	T Type		Output impedance: 1.8 kΩ (Output standard: 8P6N)
	N/E Type Rated Working Current	E type: Up to 100 mA	N type: 100 mA (Load voltage: Not more than 50 V)
Voltage Drop		2.0 V or lower (Excluding CS-16-5T)	
Off-state Current		200 μA or less (Excluding CS-16-5T)	
Indicator Lamp		Operation indication	
Use Ambient Temperature		-10 to +55°C	
Temperature Characteristics		Within ±15% (At the operating distance at +23°C)	Within ±20% (At the operating distance at +20°C)
Withstand Voltage		500 V AC 50/60 Hz (1 minute)	
Insulation Resistance		50 MΩ or higher (500 V DC)	5 MΩ or higher (500 V DC)
Vibration Resistance		Double amplitude: 1.5 mm, 10 to 55 Hz (2 h each for X, Y and Z direction)	
Impact Resistance		490 m/s <sup>2</sup> Within 11 ms (10 times each for X, Y and Z direction)	600 m/s <sup>2</sup>
Protection Level		IP66	IP50 (Dust-resistant)
Case Material		PBT	Aluminum (Detector surface: Polycarbonate)
Lead Wire		Oilproof vinyl chloride cable 2 m Outside diameter (Approx. $\phi$ 3.8) 0.3 mm <sup>2</sup> , 3 core	Oilproof vinyl chloride cable 1.5 m Outside diameter (Approx. $\phi$ 4) 0.3 mm <sup>2</sup> , 3 core
Tightening Torque		0.4 Nm or less	0.8 Nm or less
Weight (g)		Approx. 80	Approx. 100

# CS Series

## Connection and Operation

- PLC
- HMI
- SENSOR
- ENCODER
- COUNTER
- INFORMATION

- Proximity Sensor Lineup
- Selection Guide
- Outline
- Cylinder Type
- Square Type
- Capacitive Type

CS

### Connection/Operation

DC Voltage Output Type -T

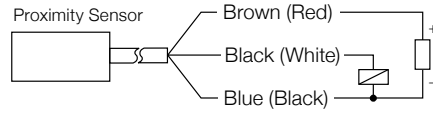

DC 3-wire Type NPN Output -N  
-E

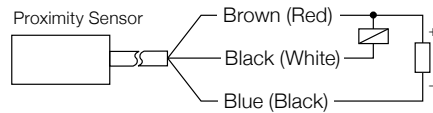

Note: indicates a load.

( Target Object    Not Present    Present )



### Installation Method

Since a capacitance proximity sensor detects the volumetric change in surrounding objects, it should be installed away from surrounding objects more than the dimensions shown in the table below.

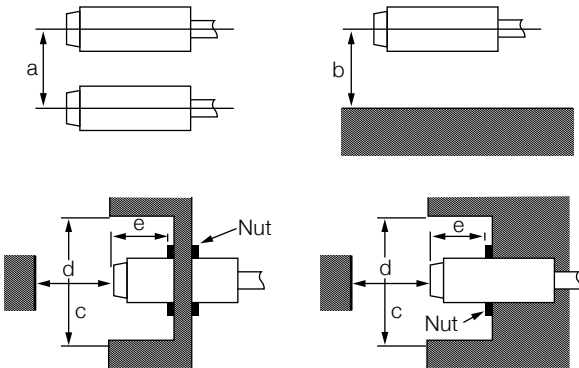

	a	b	c	d	e
CS-31	44	33	66	44	22
CS-85	60	45	90	60	30
CS-16	92	69	138	92	46
CS10-34CU	40	30	60	30	10.4

Since a capacitance proximity sensor is highly sensitive to moisture, do not use it in a place that is highly humid or directly exposed to water. Doing so may cause malfunction.

When using the sensor in a place exposed to water droplets, etc., the following measures should be taken.

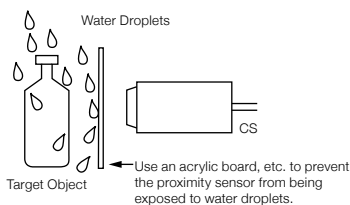

### Grounding

The operating distance changes according to the grounding state of the standard target object (50 x 50 x 1 t Iron) and capacitance proximity sensor. Use the information as reference for installing the proximity sensor and deciding the reaction material.

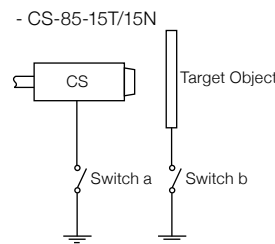

Grounding Conditions	Switch a	ON	OFF	ON	OFF
	Switch b	ON	ON	OFF	OFF
Operating Distance (mm)	15	18	6	6	

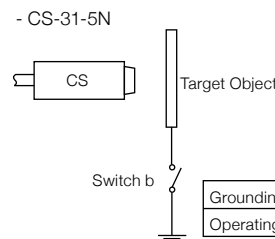

Grounding Conditions	Switch b	ON	OFF
Operating Distance (mm)		5	2.6

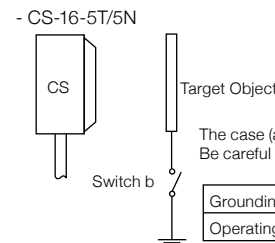

Grounding Conditions	Switch b	ON	OFF
Operating Distance (mm)		5	2.6

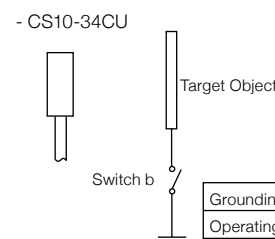

Grounding Conditions	Switch b	ON	OFF
Operating Distance (mm)		10	3.0

# CS Series

## Connection and Operation



HMI



SENSOR



ENCODER



COUNTER



INFORMATION

### Potentiometer for Adjusting the Operating Distance

A multi-rotation potentiometer for adjusting the operating distance is equipped on the back of the main body of capacitance proximity sensors. After the capacitance proximity sensor is installed, use this multi-rotation potentiometer to adjust the operating distance to the standard distance for the grounded metal plate or larger standard target object (50 x 50 x 1 t mm) or below the standard distance, according to the usage. If the multi-rotation potentiometer is turned to the right, the operating distance becomes longer, and if it is turned to the left, the operating distance becomes shorter. Although the potentiometer can be adjusted  $16 \pm 5$  turns, even if it is turned too much, there will be no damage because the potentiometer turns idly without stopping at that point.

Note that, if the operating distance is set more than the rated operating distance, operation becomes unstable. (Except for the CS10-34CU-E)

### Material Characteristics

Even if the same material is detected, the operating distance differs by size and shape of the target object. The table below shows examples of how the operating distance differs by the type of material and shape when detected by a capacitance proximity sensor. (Detection distances differ according to the electrical conductivity, relative permittivity and the water absorption state and volume.)

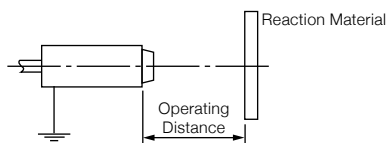

### Precautions

- ① Pay careful attention to the possibility of condensation and freezing of the detector surface and the adhesion of water, oil, and dust to the detector surface because they may cause malfunction.
- ② Note that the adherence of fluid material and powder in a non-metal container may cause malfunction.

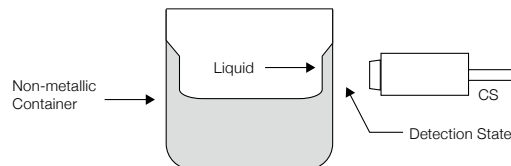

- ③ Three M4 screws are used for installing the CS-16-5T and CS-16-5N. Ensure that the screws do not penetrate the case more than 6 mm.
- ④ In the case of a 3-wire DC proximity sensor, a load with large making current (making current of 100 mA or more, such as a lamp, motor, and solenoid) may deteriorate or damage the switching element. In such case, use the sensor via a relay.

### When the Operating Distance of Iron is 100%

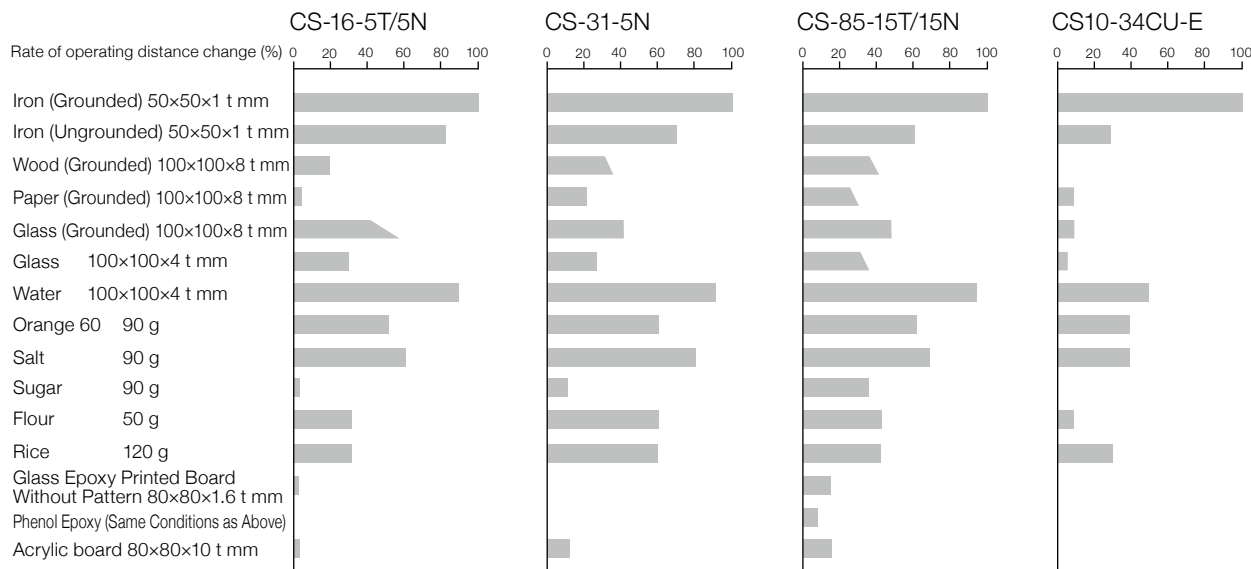

CS

# CS Series

## Connection and Operation

- PLC
- HMI
- SENSOR
- ENCODER
- COUNTER
- INFORMATION

- Proximity Sensor Lineup
- Selection Guide
- Outline
- Cylinder Type
- Square Type
- Capacitive Type

### Aluminum Thickness Characteristics

The operating distance differs according to the thickness of the target object. The figure shows the operating distance when a target object of the same size but a different thickness than the standard target object is used.

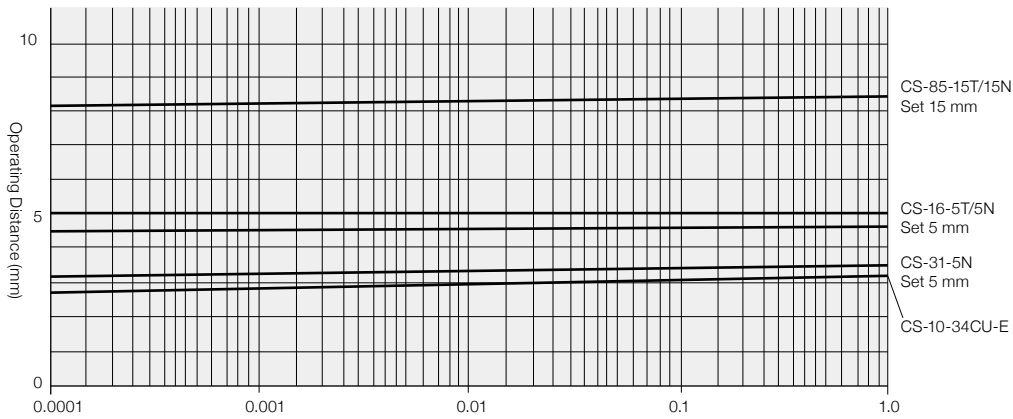

### Detection Range Diagram (Representative Examples)

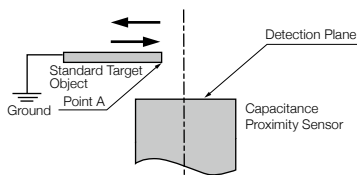

CS-31-5N

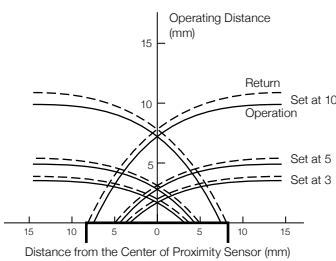

CS-85-15T  
CS-85-15N

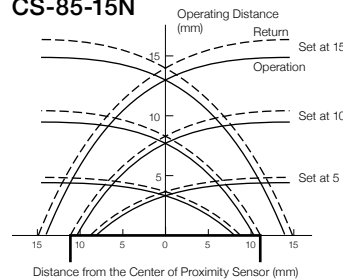

CS-16-5T  
CS-16-5N

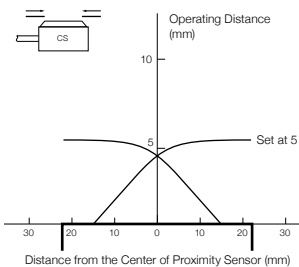

CS10-34CU-E

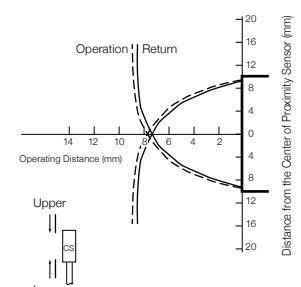
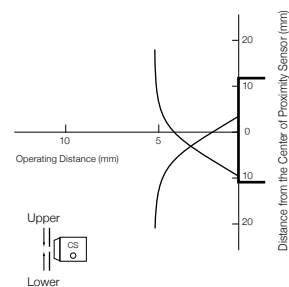
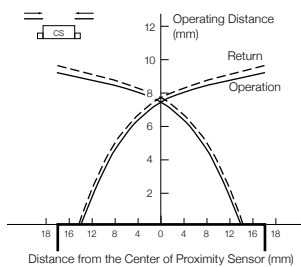

The specifications and prices described in this catalog were valid when the catalog was issued. For the latest information, contact our sales persons or see our website.

# CS Series

## Connection and Operation

### Shape Based Characteristics (Representative Examples)

CS-31-5N

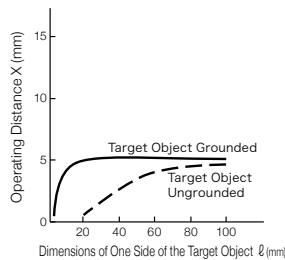

CS-85-15T  
CS-85-15N

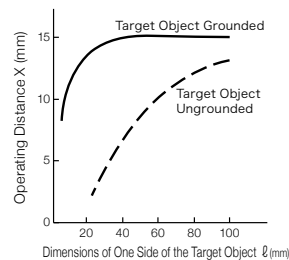

CS-16-5T  
CS-16-5N

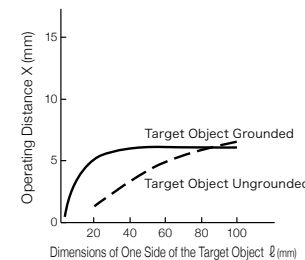

CS10-34CU-E

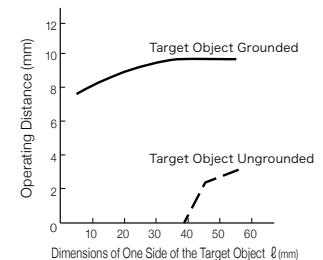

### Effects of the Amount of Water on the Detector Surface

This graph shows the measured change in operating distance when water droplets have adhered to the detector surface of a capacitance proximity sensor. When 0.2 ml of water (about 2 to 3 drops) adhere to the detector surface, the operating distance increases approx. 20% and when water flows out from the detector surface beyond the limit of surface tension, the operating distance increases 300% or more. (Except for the CS10-34CU-E)

CS-31-5N

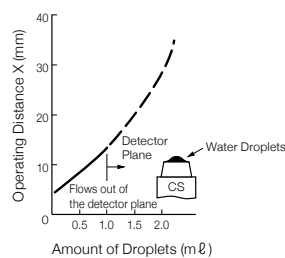

CS-85-15T  
CS-85-15N

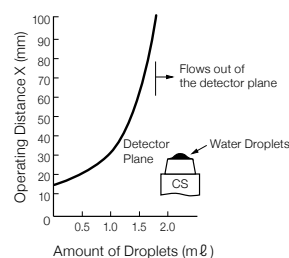

CS-16-5T  
CS-16-5N

Because the detection board is exposed, when a water droplet touches the board, the detection state starts.

CS10-34CU-E

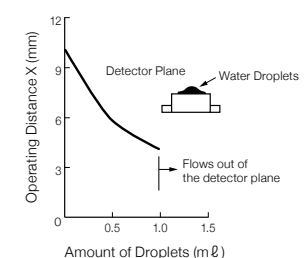

### Conducting Wire Characteristics

Thin conducting wire (copper, steel, iron, aluminum, and other conducting wire) can be detected using a capacitance proximity sensor. The figure shows the measured operating distance against the diameter of conducting wire. The characteristics are obtained when the conducting wire is grounded (or has unlimited length).

CS-31-5N

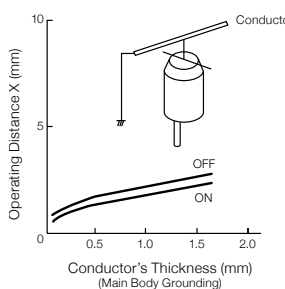

CS-85-15T  
CS-85-15N

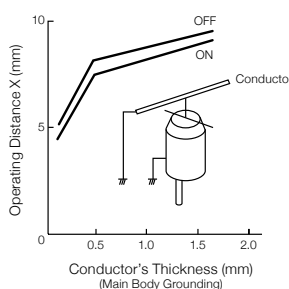

CS-16-5T  
CS-16-5N

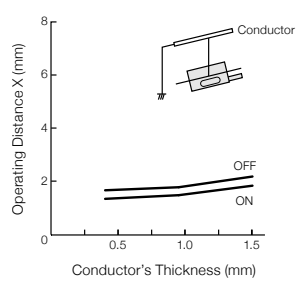

CS10-34CU-E

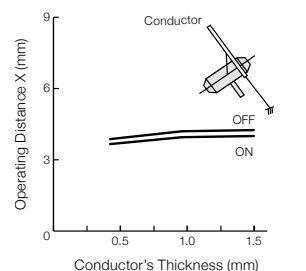
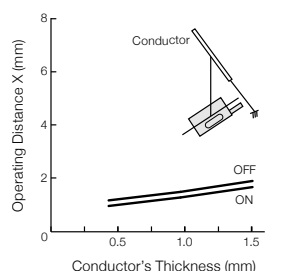
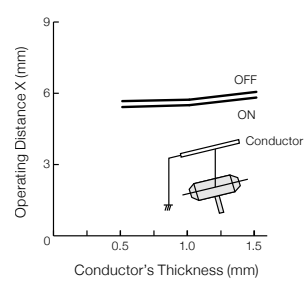

HMI



SENSOR



ENCODER



COUNTER



INFORMATION

Proximity Sensor Lineup

Selection Guide

Outline

Cylinder Type

Square Type

Capacitive Type

CS

# CS Series

## Dimensions/Reference Material

- PLC
- HMI
- SENSOR
- ENCODER
- COUNTER
- INFORMATION

- Proximity Sensor Lineup
- Selection Guide
- Outline
- Cylinder Type
- Square Type
- Capacitive Type

### Dimensions (Unit: mm)

#### CS-31-5N

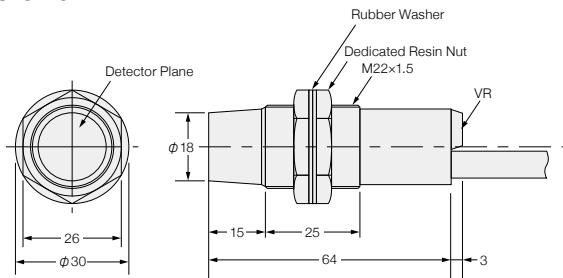

#### CS-85-15T CS-85-15N

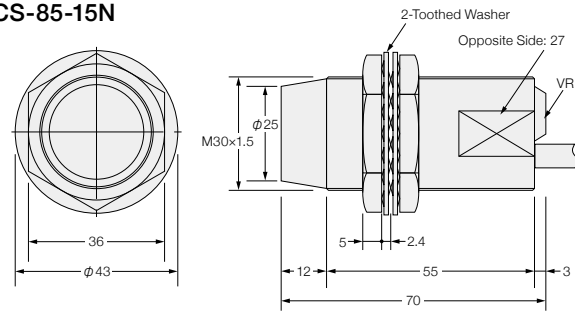

#### CS-16-5T CS-16-5N

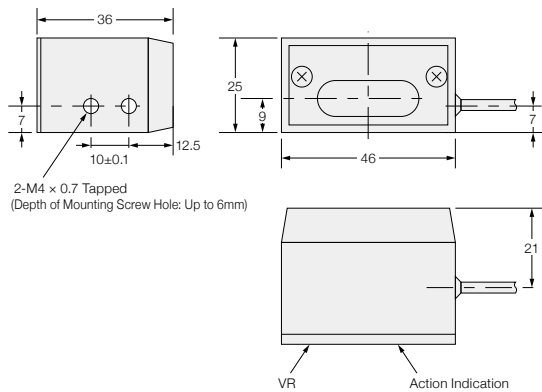

#### CS10-34CU-E

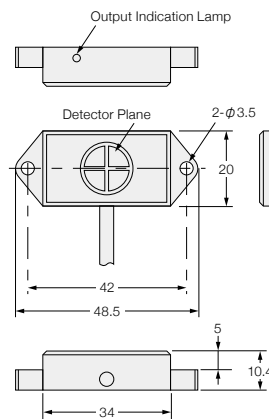

### Reference Material

#### Screw Basic Profile and Basic Dimensions

The appendix table "Basic profile and basic dimensions of screws" shows screws that are made of JIS standard material and are of special size, as a reference material.

The thin steel conduit tube screw C15 is of a size suitable for the cable outlet of the APS-14 and APS-15 series.

#### Thin Steel Conduit Tube Screw (Abolished in April 1999)

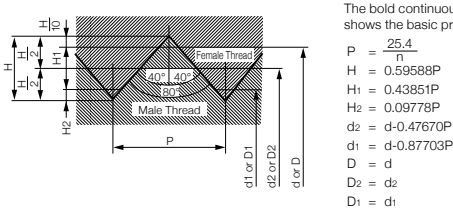

The bold continuous line shows the basic profile.

$$P = \frac{25.4}{n}$$

$$H = 0.59588P$$

$$H_1 = 0.43851P$$

$$H_2 = 0.09778P$$

$$d_2 = d - 0.47670P$$

$$d_1 = d - 0.87703P$$

$$D = d$$

$$D_2 = d_2$$

$$D_1 = d_1$$

(Unit: mm)

Nominal Designation of Thread	Nominal Diameter of Applicable Tube	Number of Threads (Per 25.4 mm) n	Pitch P (Reference)	Thread Overlap H1	Male Thread		
					Outer Diameter d	Effective Diameter d2	Thread Minor Diameter d1
					Female Thread		
					Thread Minor Diameter D	Effective Diameter D2	Inner Diameter D1
C15	15	18	1.4111	0.619	15.900	15.227	14.663
C19	19	16	1.5875	0.696	19.100	18.343	17.708
C25	25	16	1.5875	0.696	25.400	24.643	24.008
C31	31	16	1.5875	0.696	31.800	31.043	30.408
C39	39	16	1.5875	0.696	38.100	37.343	36.708
C51	51	16	1.5875	0.696	50.800	50.043	49.408
C63	63	16	1.5875	0.696	63.500	62.743	62.108
C75	75	16	1.5875	0.696	76.200	75.443	74.808