

PS3000-BA

Installation Guide

Caution

Be sure to read the "Warning/Caution Information" on the attached sheet before using the product.

Package Contents

- (1) PS-B Unit (1)
- (2) English and Japanese Installation Guides (one of each) <This Guide>
- (3) Warning/Caution Information (1)
- (4) Installation Fasteners (Fasteners:2, Screws: 4)

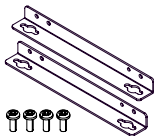

- (5) USB Cable Clamp (2 ports) (2)

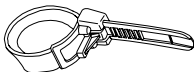

- (6) USB Holder (1), Screw (1)

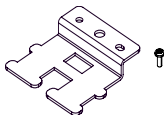

- (7) Power Connector (1)

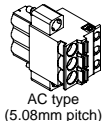

IMPORTANT

- Be careful when installing the PS-B not to damage the built-in HDD.

This unit has been carefully packed, with special attention to quality. However, should you find anything damaged or missing, please contact your local PS-B distributor immediately.

When you order a PS-B unit built to your specifications, that PS-B package should include each optional item's Installation Guide. Please use that guide to check the contents of each optional item's package.

About the Manual

For the detailed information on PS-B, refer to the following manuals.

- PS-3000B Series Hardware Manual
- PS-3000B Series Reference Manual
- API Reference Manual
Manual can be downloaded from Pro-face Home Page.

URL

<http://www.pro-face.com/otasuke/>

NOTE

- The drivers and utilities for PS-B can be downloaded from Pro-face Home Page.

Industrial automation

Elincom Group



European Union: www.elinco.eu



Russia: www.elinc.ru

Part Names and Functions

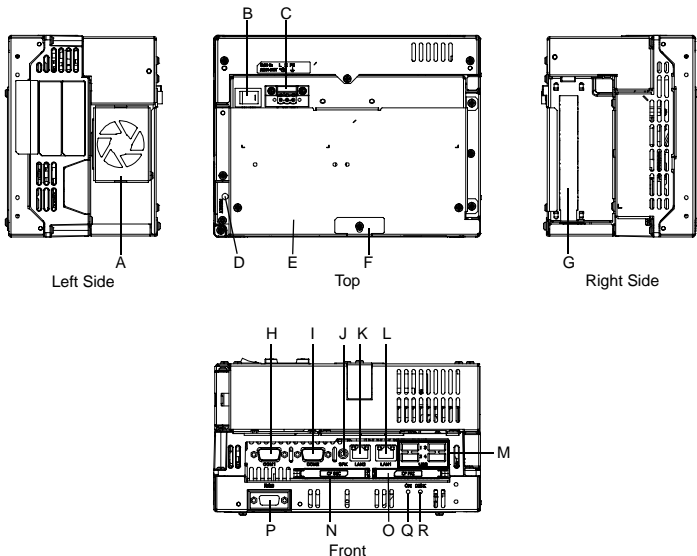

	Name	Description
A	Cooling FAN	—
B	Power Switch	—
C	Power Connector	—
D	Reset Switch (RESET)	Used to restart PS-B / turn on the power. Used in combination with System Set SW. Please refer to "Switches" for details.
E	Expansion Board Cover	—
F	Expansion Board Support	—
G	Expansion unit Interface	1 port. Used to attach the PCI Unit.
H	Serial Interface (COM1)	Dsub 9-pin plug type. RS-232C.
I	Serial Interface (COM2)	Dsub 9-pin plug type. RS-232C, RS-422, RS-485 Changeover. RI/+5V Changeover.
J	Speaker Output Interface (SPK)	1 port. (Mini pin jack connector)

K	Ethernet Interface (LAN2)	10BASE-T/100BASE-TX/1000BASE-T Auto Changeover and Wake On LAN feature. This interface uses an RJ-45 type modular jack connector (8 pins).										
L	Ethernet Interface (LAN1)	10BASE-T/100BASE-TX Auto Changeover. This interface uses an RJ-45 type modular jack connector (8 pins).										
M	USB Interface (USB)	4 ports. USB 2.0 compatible. Uses a "TYPE-A" connector. <table border="1"> <tr> <td>Power supply voltage</td> <td>5 VDC \pm5%</td> </tr> <tr> <td>Output current</td> <td>Each port: 500mA (max.), 4 ports total: 500mA (max.)</td> </tr> <tr> <td>The maximum communication distance</td> <td>5m</td> </tr> </table>	Power supply voltage	5 VDC \pm 5%	Output current	Each port: 500mA (max.), 4 ports total: 500mA (max.)	The maximum communication distance	5m				
Power supply voltage	5 VDC \pm 5%											
Output current	Each port: 500mA (max.), 4 ports total: 500mA (max.)											
The maximum communication distance	5m											
N	Secondary CF Card Interface	Open the cover and insert the CF Card. CF Card (Type I/II-compliant) is available. IDE-type connection.*1										
O	Primary CF Card Interface											
P	Analog RGB Interface	A mini D-sub 15 pin (socket) is used to connect a RGB monitor on the market or FP Series unit manufactured by Pro-face.										
Q	Power LED / RAS Status Lamp (ON)	<table border="1"> <thead> <tr> <th>LED</th> <th>PS-B Status</th> </tr> </thead> <tbody> <tr> <td>Green (lit)</td> <td>Normal Operation (power is on)</td> </tr> <tr> <td>Green (blinking)</td> <td>Soft OFF state</td> </tr> <tr> <td>Orange (lit)</td> <td>System Monitor Error RAS Error</td> </tr> <tr> <td>Not lit</td> <td>Power is OFF</td> </tr> </tbody> </table>	LED	PS-B Status	Green (lit)	Normal Operation (power is on)	Green (blinking)	Soft OFF state	Orange (lit)	System Monitor Error RAS Error	Not lit	Power is OFF
LED	PS-B Status											
Green (lit)	Normal Operation (power is on)											
Green (blinking)	Soft OFF state											
Orange (lit)	System Monitor Error RAS Error											
Not lit	Power is OFF											
R	HDD / IDE Access Lamp (DISK)	<table border="1"> <thead> <tr> <th>LED</th> <th>PS-B Status</th> </tr> </thead> <tbody> <tr> <td>Green (lit)</td> <td>Access to HDD or IDE.</td> </tr> <tr> <td>Not lit</td> <td>Not access to HDD or IDE.</td> </tr> </tbody> </table>	LED	PS-B Status	Green (lit)	Access to HDD or IDE.	Not lit	Not access to HDD or IDE.				
LED	PS-B Status											
Green (lit)	Access to HDD or IDE.											
Not lit	Not access to HDD or IDE.											

*1 Since an IDE-type connection is used, the unit is not hot-swappable. When inserting/removing the CF Card, be sure that power is turned OFF.

IMPORTANT

- When attaching peripheral units to the PS-B, be sure the PS-B's power cord is disconnected from the main power supply.

General Specifications

■ Electrical Specifications

Power Supply	Input Voltage	AC100/240V
	Rated Voltage	AC85 to 265V
	Rated Frequency	50/60Hz
	Allowable Voltage Drop	1 cycle or less (Voltage drop interval must be 1s or more.)
	Power Consumption	120VA or less
	In-Rush Current	For AC100V (Ambient Temperature): 30A (max.) For AC240V (Ambient Temperature): 50A (max.)
Voltage Endurance	AC1500V 20mA for 1minute (between charging and FG terminals)	
Insulation Resistance	DC500V 10M Ω (min.) (between charging and FG terminals)	

■ Environmental Specifications

Physical	Surrounding Air Temperature	0 to 50°C :without HDD 5 to 50°C :with HDD
	Storage Temperature	-20 to +60°C
	Ambient Humidity	10 to 90% RH (Not condensing, wet bulb temperature: 39°C or less. Wet bulb temperature with HDD: 29°C or less.)
	Storage Humidity	10 to 90% RH (Not condensing, wet bulb temperature: 39°C or less.)
	Dust	Free of dust
	Pollution Degree	For use in Pollution Degree 2 environment

IMPORTANT

- When using any of the PS-B's optional devices, be sure to check that device's specifications for any special conditions or cautions that may apply to its use.
- Be aware that not only does the Hard Disk have a fixed lifetime, but that accidents can always occur. Therefore, be sure to back up your Hard Disk's data regularly, or prepare another Hard Disk unit that can be used for backup.
- The Hard Disk lifetime given here may be reduced due to unforeseen environmental factors, however, generally speaking, the disk should last for 20,000 hours (of operation) or approximately 5 years, whichever comes first at an operating temperature of 20°C and 333 hours of operation per month. (HDD access frequency of 20% or less)

- Using the Hard Disk in an environment that is excessively hot and/or humid will shorten the disk's usage lifetime. A wet bulb temperature of 29°C or less is recommended. This is equivalent to the following data.

Temperature	at 35°C	at 40°C
Humidity	no higher than 64% RH	no higher than 44% RH

- In order to extend the lifetime of the hard disk, Pro-face recommends you set the Windows® 2000's [Control panel]-[Power Options]-[Turn off hard disks] selection or the Windows® XP's [Control panel]-[Performance and Maintenance]-[Power Management option]-[Turn off hard disks] selection to turn the hard disk off when the unit is not being operated. A setting of 5 minutes is recommended.

Switches

1. To change the switch settings

The switches are on the PS-B's circuit board. First of all, the cover is detached.

■ For PS3000-BA without built-in HDD unit

- Unscrew the screws (2) from the Expansion Board Cover, and remove the cover.

When replacing the cover, the torque required for these screws is 0.5 to 0.6 N•m.

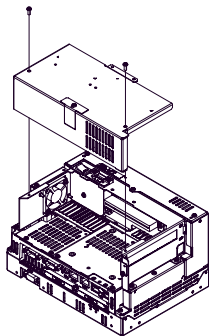

- Unscrew the screws (2) of the IDE cover and remove the IDE cover. When

replacing the cover, the torque required for these screws is 0.5 to 0.6 N•m.

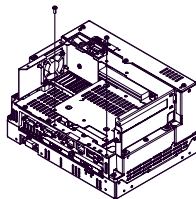

■ For PS3000-BA with built-in HDD unit

- Unscrew the screws (2) from the Expansion Board Cover, and remove the cover.

When replacing the cover, the torque required for these screws is 0.5 to 0.6 N•m.

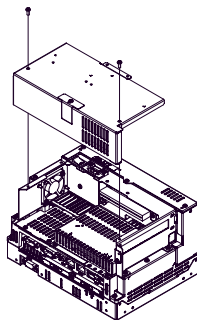

- (2) Unscrew the screws (2) of the HDD cover and remove the HDD cover. When replacing the cover, the torque required for these screws is 0.5 to 0.6 N•m.

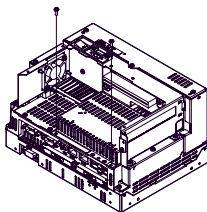

- (3) Unscrew the screws (4) of the HDD unit, remove the cable connector from IDE I/F while lifting up the HDD unit, and remove it.

To replace the HDD unit, connect the cable connector to IDE I/F securely and fix the HDD unit with the screws (4). (For the location of the IDE/IF, refer to the following figure “Inside of the top”). The torque required for these screws is 0.5 to 0.6N•m.

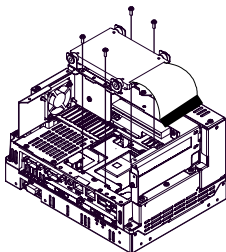

2. About Switches

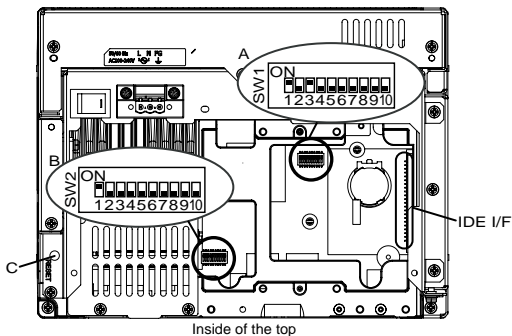

Switch Location	Switch Name	Description
A	System Set SW (SW1)	10-point dip switch. For System Set SW details and the factory settings details, see Table (1).
B	Serial Mode Select SW (SW2)	10-point dip switch. Designates COM2 communication settings. For Serial Mode Select SW details, see Table (2). Factory Settings: For RS-232C
C	Reset SW	<p>■ Power Button Mode</p> <p>In advance, turn ON the System Set SW No.6. For Windows® 2000, the mode of [When I press the power button on my computer] that is selected from PS-B's start menu-[Settings]-[Control panel]-[Power Options]-[Advanced]-[Power buttons] is operated when pressing the Reset SW. For Windows® XP, the mode of [When I press the power button on my computer] that is selected from [Control panel]-[Performance and Maintenance]-[Power Management option]-[Advanced] is operated.</p> <p>NOTE</p> <ul style="list-style-type: none"> PS-B restarts when pressing the switch at the Soft OFF*1 state (the Power LED / RAS Status Lamp is blinking in green). <p>■ Reset Switch Mode</p> <p>In advance, turn OFF the System Set SW No.6. PS-B restarts when pressing the Reset SW.</p>

*1 The Soft OFF refers to the state that Windows® has been shut down and the power is provided only for the electric circuit to boot system. This Soft OFF State is different from what is System Standby set by Windows®.

Switch No.	Description	ON	OFF	Notes
1	Used for the system.	Reserved	Reserved	Factory Settings: ON
2	Used for the system.	Reserved	Reserved	Factory Settings: OFF
3	Used for the system.	Reserved	Reserved	Factory Settings: ON
4	Used for the system.	Reserved	Reserved	Factory Settings: OFF
5	Used for the system.	Reserved	Reserved	Factory Settings: OFF
6	Changes Reset SW mode.	Power button	Reset SW	Factory Settings: OFF
7	Used for the system.	Reserved	Reserved	Factory Settings: OFF

Switch No.	Description	ON	OFF	Notes
8	Changes COM2 (RI <----> +5V). (enabled only when RS-232C mode)	+5V Output	RI	Factory Settings: OFF
9	Changes a Master/Slave setting for Primary CF Card Interface.	Slave	Master	The factory settings depend on your selected built-in accessory.
10	Used for the system.	Reserved	Reserved	Factory Settings: OFF

Table 1) System Set Switches

Switch No.	Description	ON	OFF	RS-232C	RS-422	RS-485
1	Changes COM2's communication method	RS-232C	RS-422/RS-485	ON	OFF* ¹	OFF* ¹
2	Changes COM2's communication method	RS-422/RS-485	RS-232C	OFF	ON	ON
3	Changes COM2's communication method	RS-422/RS-485	RS-232C	OFF	ON	ON
4	Changes TX data's output mode	TX data output is controlled via the RTS signal.	TX data output is NOT controlled via the RTS signal. (normally output)	OFF	ON/OFF	ON/OFF* ³
5	Switches the TX termination resistance ON/OFF	Inserts termination resistance of 220Ω between TXA and TXB.	No termination	OFF	ON	ON/OFF* ²
6	Switches the RX termination resistance ON/OFF	Inserts termination resistance of 220Ω between RXA and RXB.	No termination	OFF	ON	ON/OFF* ²
7	Switches the shorting of TXA and RXA ON/OFF	Shorts TXA and RXA (RS-485 mode)	No shorting (RS-422 mode)	OFF	OFF	ON

Switch No.	Description	ON	OFF	RS-232C	RS-422	RS-485
8	Switches the shorting of TXB and RXB ON/OFF	Shorts TXB and RXB (RS-485 mode)	No shorting (RS-422 mode)	OFF	OFF	ON
9	RTS Automatic control mode (enabled only when RS-485 mode)	The data is automatically controlled via the RTS signal.	The data is not automatically controlled via the RTS signal.	OFF	OFF	ON/OFF*3
10				OFF	OFF	ON/OFF*3

Table 2) Serial Mode Select Switches

*1 Be sure to keep the settings, "OFF" for RS-422 or RS-485.

*2 If you use the termination resistance, base your settings on the connection specifications.

*3 To control TX output driver via RTS automatically, set ON. Be sure to set SW No.4 OFF.

Not to control TX output driver via RTS automatically, set OFF. Be sure to set SW No.4 ON.

Serial Mode Select Switches (SW4 to SW10) operate as shown in the circuit diagram below.

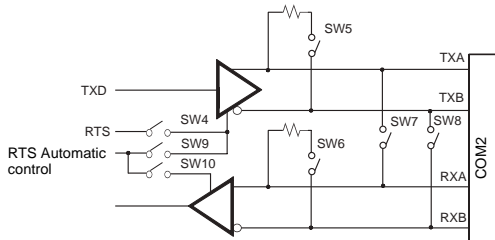

External Interfaces

IMPORTANT

- This PS-B unit's serial port is not isolated. When the host (PLC) unit is also not isolated, and to reduce the risk of damaging the RS-232C/RS-422/RS-485 circuit, be sure to connect the #5 SG (Signal Ground) terminal.

■ Serial Interface (COM1, COM2)

Interfit Bracket	#4-40 (UNC)
------------------	-------------

◆COM1

Pin #	RS-232C	
	Signal Name	Meaning
1	CD	Carrier Detect
2	RD (RXD)	Receive Data
3	SD (TXD)	Send Data
4	ER (DTR)	Data Terminal Ready
5	GND	Signal Ground
6	DR (DSR)	Data Set Ready
7	RS (RTS)	Request to Send
8	CS (CTS)	Clear to Send
9	CI (RI)	Called status display
FG	FG	Frame Ground (Common with SG)

◆COM2

COM2 can be changed to either RS-232C, RS-422 or RS-485. (The factory setting is RS-232C.) To change this setting, set Serial Mode Select switch on the circuit board to the desired position.

Please refer to "Switches" for details.

Pin #	RS-232C	
	Signal Name	Meaning
1	CD	Carrier Detect
2	RD (RXD)	Receive Data
3	SD (TXD)	Send Data
4	ER (DTR)	Data Terminal Ready
5	GND	Signal Ground
6	DR (DSR)	Data Set Ready
7	RS (RTS)	Request to Send

Pin #	RS-232C	
	Signal Name	Meaning
8	CS (CTS)	Clear to Send
9	CI (RI)/ +5V*1	Called status display/ +5V Output (Switching available)
FG	FG	Frame Ground (Common with SG)

*1 To change the RI/+5V setting of #9 pin set System Set switch to the desired position.

Pin #	RS-422	
	Signal Name	Meaning
1	RDA	Receive Data A (+)
2	RDB	Receive Data B (-)
3	SDA	Send Data A (+)
4	NC	No Connection
5	GND	Signal Ground
6	NC	No Connection
7	SDB	Send Data B (-)
8	NC	No Connection
9	NC	No Connection
FG	FG	Frame Ground (Common with SG)

Pin #	RS-485	
	Signal Name	Meaning
1	DATA +	Send/Receive Data(+)
2	DATA -	Send/Receive Data(-)
3	NC	No Connection

Pin #	RS-485	
	Signal Name	Meaning
4	NC	No Connection
5	GND	Signal Ground
6	NC	No Connection
7	NC	No Connection
8	NC	No Connection
9	NC	No Connection
FG	FG	Frame Ground (Common with SG)

IMPORTANT

- Be sure to connect pin number 5 (GND) of COM1 and COM2 (RS-232C) to the host unit's Signal Ground terminal.
- Be sure to confirm what settings will be used by the other device and set the slide switches accordingly. Failure to do so can result in a unit malfunction or damage.
- Whenever changing the PS-B switches, be sure to first turn the PS-B's power supply OFF. Failure to do so can cause a PS-B malfunction.
- Connect the FG terminal line to the shell.
- FG and SG terminals are internally connected in the PS-B. When connecting to another device, be sure not to create an SG shorting loop in your system.

Installations

1. Installation Requirements

- For easier maintenance, operation, and improved ventilation, be sure to install the PS-B at least 50mm [1.97in.] away from adjacent structures and other equipment.

120mm [4.72in.] space (minimum) is necessary at the front for cable curve.

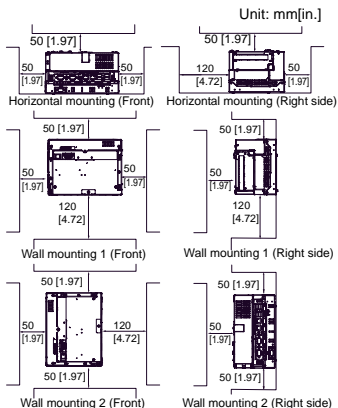

- Be sure that the surrounding air temperature and the ambient humidity are within their designated ranges.
(Surrounding air temperature: with HDD 5 to 50°C without HDD 0 to 50°C, Ambient humidity: 10 to 90% RH, Wet bulb temperature: 39°C or less, with HDD: 29°C or less)
Check the surrounding air temperature 30 mm [1.18 in.] away from the main unit.
Ex.: Horizontal mounting

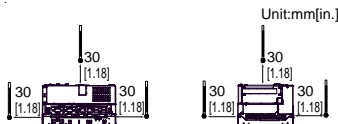

- Be sure that heat from surrounding equipment does not cause the PS-B to exceed its standard operating temperature.

2. PS-B Installation

IMPORTANT

- Determine the thickness of the board in consideration of its strength. The minimum thickness of a board is 1.6 mm [0.06 in.] for M4 screws.
- (1) Create holes and perform the necessary processing on the board according to the drawing of mounting holes.

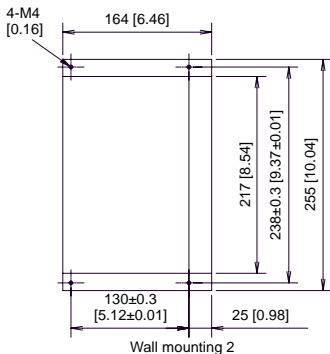
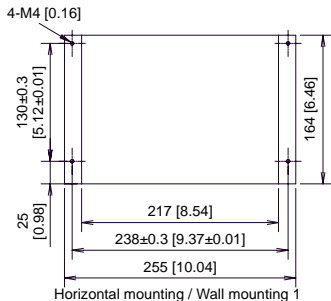

- (2) Attach installation fasteners with the accompanying four M3 screws to the PS-B unit. Pay close attention to the direction of

the fasteners. The torque required to tighten these screws is 0.5 to 0.6 N•m.

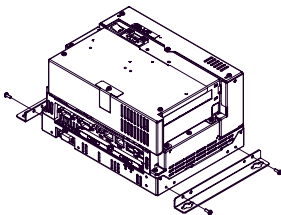

- (3) Attach the PS-B unit to the board with the M4 screws: First, tighten M4 screws temporarily on the board; mount installation fasteners temporarily onto M3 screws; and then tighten the screws until the PS-B unit is securely fixed. The torque required to tighten these screws is 1.0 to 1.2 N•m

Ex.: Horizontal mounting / Wall mounting 1

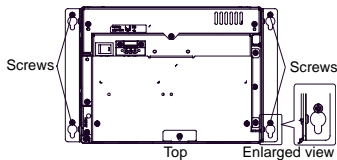

IMPORTANT

- Tightening the screws with too much force can damage the PS-B unit.
- Be sure to insert installation fasteners in the recessed portion of an installation fasteners hole. If the fasteners are not correctly attached, the PS-B unit may shift or fall out of the panel.
- M4 screws are not included with the PS-B unit. Please prepare them by yourself.
- Depending on the panel's material and design, the panel's installation surface may need to be strengthened. If high levels of vibration are expected and the PS-B unit's installation surface (i.e. an operation panel's door, etc.) can move

(i.e. open or close) due consideration should be given to the PS-B unit's weight.

Wiring

⚠ WARNING

- Be sure to confirm that power is not being supplied to the PS-B unit before wiring. Failure to do so can result in an electric shock.
- Any other power level can damage both the PS-B and the power supply.
- When the FG terminal is connected, be sure the wire is grounded.

1. Wiring the power supply cable

IMPORTANT

- When the FG terminal is connected, be sure the wire is grounded. Not grounding the PS-B unit will result in excessive noise. Use your country's applicable standard for grounding.

■ Power Cord Specifications

Use copper conductors only.

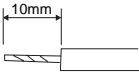
Power Cord Diameter	0.75 to 2.5mm ² (18 to 12 AWG)
Conductor Type	Simple or Stranded Wire*1
Conductor Length	

*1 If the Conductor's end (individual) wires are not twisted correctly, the end wires may either short against each other, or against an electrode.

■ Wiring

When connecting the power cord, use the following items when performing wiring. (Items are made by Phoenix Contact.)

Recommended Driver	SZS 0.6x3.5 (1205053)
Recommended Pin Terminals	AI 0.75-10GY (3201288) AI 1-10RD (3200182) AI 1.5-10BK (3200195) AI 2.5-12BU (3200962)
Recommended Pin Terminal Crimp Tool	CRIMPFOX ZA3 (1201882)

NOTE

- Accompanying AC type power supply connector is CA7-ACCNL-01 from Pro-face or FKC2.5/3-STF-5.08 is manufactured by Phoenix Contact.

■ Connecting the Power Cord

- (1) Confirm that the power is not supplied to the PS-B unit.
- (2) Unplug the power connector from the top of the PS-B unit.
- (3) Push the Opening button with a small and flat screw driver to open the desired pin hole.
- (4) Insert each pin terminal into its each hole. Release the Opening button to clamp the pin in place.

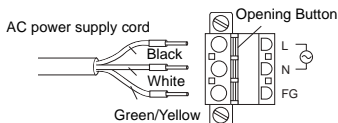

- (5) After inserting all three pins, insert the Power Plug into the Power Connector at PS-B. Fix the plug with two (2) slot screws.

IMPORTANT

- The torque required to tighten these screws is 0.5 to 0.6N•m.
- To prevent the possibility of a terminal short, use a pin terminal that has an insulating sleeve.

2. Power Supply Cautions

- Input and Output signal lines must be separated from the power control cables for operational circuits.
- To improve the noise resistance, be sure to twist the ends of the power cord wires before connecting them to the Power connector (Plug).
- The PS-B unit's power supply cord should not be bundled with or kept close to main circuit lines (high voltage, high current), or input/output signal lines.
- To reduce noise, make the power cord as short as possible.
- If the supplied voltage exceeds the PS-B unit's range, connect a voltage transformer.
- Between the line and the ground, be sure to use a low noise power supply. If there is an excess amount of noise, connect a noise reducing transformer.
- The temperature rating of field installed conductors: 75°C only.

IMPORTANT

- Use voltage and noise reducing transformers with capacities exceeding Power Consumption value.
- Connect a surge absorber to handle power surges.

IMPORTANT

- Be sure to ground the surge absorber (E1) separately from the PS-B unit (E2). Select a surge absorber that has a maximum circuit voltage greater than

that of the peak voltage of the power supply.

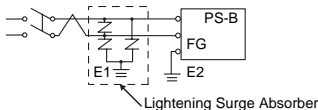

3. Grounding Cautions

- Be sure to create an exclusive ground for the Power Cord's FG terminal. Use a grounding resistance of 100Ω, a wire of 2mm² or thicker, or your country's applicable standard.
- The SG (signal ground) and FG (frame ground) terminals are connected internally in the PS-B unit. When connecting the SG line to another device, be sure that the design of the system/connection does not produce a shorting loop.
- The grounding wire should have a cross sectional area greater than 2mm². Create the connection point as close to the PS-B unit as possible, and make the wire as short, as possible. When using a long grounding wire, replace the thin wire with a thicker wire, and place it in a duct.

Exclusive Grounding (BEST)

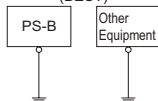

Common Grounding (OK)

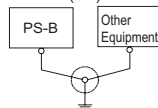

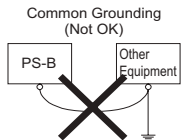

4. Input/Output Signal Line Cautions

- All PS-B Input and Output signal lines must be separated from all operating circuit (power) cables.
- If this is not possible, use a shielded cable and ground the shield.
- To improve noise immunity, it is recommended to attach a ferrite core to the power cord.

To prevent the USB cable from coming off

■ Attaching the USB Cable Clamp

- (1) Place the PS-B unit face-down on a flat surface as shown below. Your PS-B unit has four USB connectors.

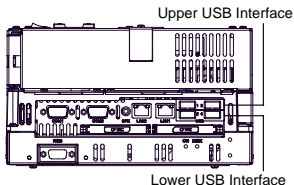

NOTE

- When using two or more USB ports, be sure to first connect one USB cable to the upper USB connector, and then connect the second USB cable to the lower USB connector.
- When using only one of the USB ports, be sure to use the upper USB connector. This

allows you to securely clamp the USB cable in the cable clamp.

- (2) Unscrew the two (2) attachment screws used to hold the Expansion Board Cover in place, and open the Expansion Board Cover.

SEE → “Switches” - “To change the switch settings” on page 5

- (3) Fix the USB holder with a screw. The torque required for this screw is 0.5 to 0.6 N•m. Next, as shown, insert the USB Cable Clamp’s band through the hollow of the holder. Pass the USB cables through the Cable Clamp’s band and securely tighten the clamp band around the cables.

NOTE

- Be sure the clamp is securely holding the USB cable’s plug and collar.
- Be sure the clamp is positioned as shown below, with the clamp pointing upwards - not to the side. This is to keep the clamp from interfering with nearby connectors and their cables.

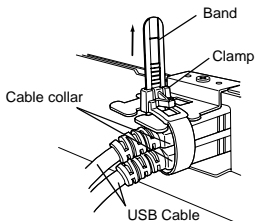

- (4) Replace the Expansion Board Cover and reattach two (2) attachment screws. The torque required for these screws is 0.5 to 0.6 N•m.

■ Removing the USB Cable Clamp

- (1) To remove the clamp from the USB cables, push down on the clamp strap’s clip to release it while pulling up on the clamp.

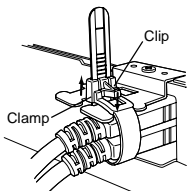

Voltage Directives, EN55011 Class A, EN61000-6-2, and EN60950-1 directives.

Inquiry

Do you have any questions about difficulties with this product? Please access our site anytime that you need help with a solution.

<http://www.pro-face.com/otasuke/>

UL/c-UL/CSA Approval

The following units are UL/c-UL/CSA listed products:

(UL File No.E220851, CSA File No.219866)

Product Model No.	UL/c-UL/CSA Registration Model No.
PS3000-BA	3681601-01

These products conform to the following standards:

■ UL508

Industrial Control Equipment

■ CSA-C22.2 No.142-M1987

Process Control Equipment

<Cautions>

Be aware of the following items when building the PS-B into an end-use product:

- The PS-B unit is approved as an open-type unit.
- Install the PS-B unit on a flat surface. Create space between the PS-B unit, the structure that the PS-B unit is attached to and immediate parts according to the mounting conditions. The temperature must be checked on the final product in which the PS-B is installed.

Note

Please be aware that Digital Electronics Corporation shall not be held liable by the user for any damages, losses, or third party claims arising from the uses of this product.

CE Marking

- PS3000-BA units are CE marked products that conform to EMC directives and Low

Digital Electronics Corporation

8-2-52 Nanko-higashi

Suminoe-ku, Osaka 559-0031

JAPAN

TEL: +81-(0)6-6613-3116

FAX: +81-(0)6-6613-5888

<http://www.pro-face.com/>

© Copyright 2008 Digital Electronics Corporation. All rights reserved.

PFX102309H .PS3000BA-MT01E-BTH
2008.4 JM/A